

logistics

workspace
solutions



HUMAN
WORKSPACE

HUMAN WORKSPACE

who we are



At Human Workspace, we take pride in our origins, which began in 2000 with the Finnish company Treston Oy (formerly Sovella Oy), a global supplier and manufacturer of modular technical furniture. Like Treston—of which we have been an independent importer for the Benelux since 2013—we believe in the power of adaptability. With a creative approach, we enjoy thinking in solutions that enhance and support the workplace, helping our customers anticipate changes.

contributing to the solution

Our workspaces are designed to help clients achieve their business goals. Whether it's about improving performance or reducing work-related injuries and sick leave, we are here to support you. How do we do this? By applying a few key principles in designing our workspace solutions:

1

Sick leave often arises from work-related conditions affecting the musculoskeletal system. By applying good **ergonomics** to the workspace, these issues can be prevented.

By applying LEAN/5S principles to the workspace, we prevent the waste of time and resources. A smart layout enhances the speed, efficiency, and **productivity** of operations.

2

3

Modularity and adaptability are an essential part of our workspace solutions. It enables clients to implement ongoing improvements and contribute to a circular economy.

4 principles
for achieving the
best workspace
solution

Automation is crucial for faster and more accurate operations. We apply technological applications to our workspaces, that can be seamlessly integrated with automated systems.

4

the way **we work**

To prevent waste of time and resources and to provide our clients with clarity and transparency, we follow the **Human Workspace Design Plan** when assembling our workspace solutions.

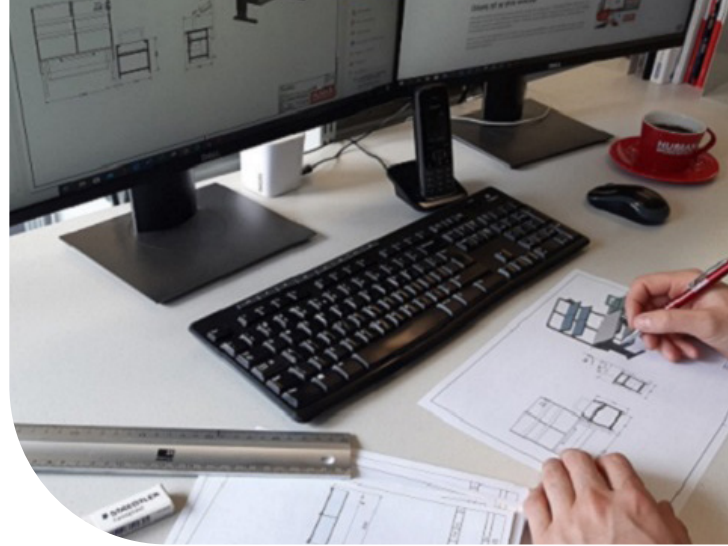

ANALYSIS

We map out workspace needs, wishes, tasks, processes, and working environment.

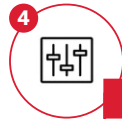

OPTIMIZATION

Thanks to our modular product design and flexible approach, adjustments are easy to make.



CONFIGURATION

We create workspace solutions that align with our customers' ambitions and goals.



INSTALLATION

A team of professional mechanics ensures neat installation and maintenance on-site.



PROTOTYPE

We design and produce prototypes so that clients can test the solution.



SERVICE

We maintain the workspaces and make adjustments to help our clients continuously adapt to changes.



from standard products to **100% tailored solutions**

For the implementation of our workspace solutions, we have a very extensive range of off-the-shelf products for the workspace, such as workbenches, mobile workstations, trolleys, carts, and various storage systems. Where necessary, we can enhance these with technological applications and customized solutions. Fully customised solutions is also an option.

project services

Are you working on a set-up for workspaces in your new facility or an extension of your existing facilities? And does this involve a significant amount of engineering and customization?

Our project team is there to help. Our project services include a dedicated project manager, project support, engineering, 3D drawings, installation and maintenance services. We will ensure that your project runs smoothly and meets all your needs!

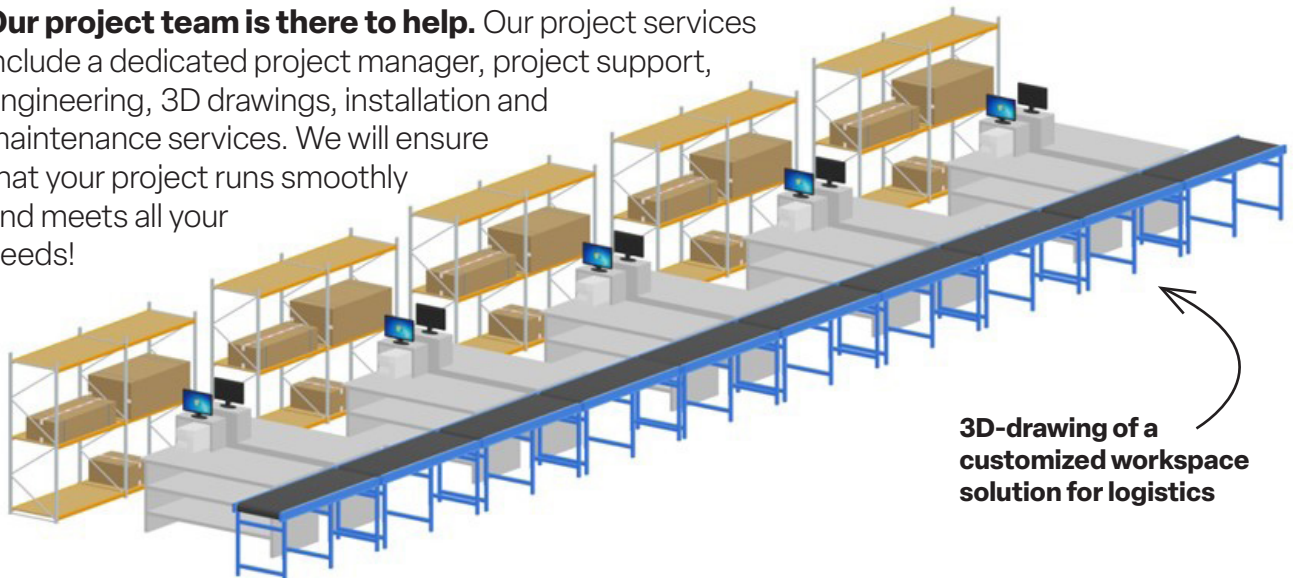

3D-drawing of a customized workspace solution for logistics

online services

In our online shop, you will find an extensive range of products for the workspace, including top brands such as Treston, Ergolastec, Notrax, and Helge Nyberg. Everything for the workspace in one location! With a personal customer account, ordering is quick and easy, and you can take advantage of our online benefits.

Create your **online account** en benefit from online deals!



With our workspace solutions, we serve various markets, such as logistics, (ESD) manufacturing and assembly, pharma, observation, and R&D. We combine our knowledge of different processes with solid product expertise and a listening ear, enabling us to provide the most suitable, often creative workspace solutions.

logistics

workspace solutions **for logistics**

Working in a logistics environment can be physically demanding and intense. It requires a lot from both people and resources. Also, logistic processes are continuously undergoing changes and improvements, and tasks often need to be performed quickly and accurately.

With our workspace solutions for logistics, we respond to these challenges. We design our workspaces to provide a comfortable and healthy environment for employees, while also enhancing the speed and efficiency of various logistical operations:

- **inbound**
- **Value Added Services (VAS)**
- **packing & repacking**
- **outbound**
- **Quality Control (QC)**
- **returns**



logistics



TRESTON

packing benches

To create the most suitable workspace solution, we can choose from the modular packing benches of the Finnish brand Treston, of which we are the importer for the Benelux. These robust packing benches are available in various widths and depths, offering a high degree of ergonomics and flexibility.

Treston Concept packing bench

The robust and ergonomic Concept packing bench has an impressive load capacity of up to 500 kg. This bench is available with electric, manual, or fixed height adjustment and provides space for numerous accessories, allowing you to fully customize the workspace to your needs.



Treston QuatreX packing bench

The electrically height-adjustable packing bench can go from 710 to 1210 mm in just 14 seconds. The four legs provide extra stability, allowing you to work with confidence. The load capacity of the QuatreX is 300 kg.

Treston TED packing bench

The TED packing bench is equipped with a motor, allowing the workbench to be quickly adjusted in height. The load capacity of this packing bench is 200 kg, making it particularly suitable for lighter packaging tasks.





Treston TP packing bench

The basic four-legged TP packing bench can be adjusted to the desired height during assembly and is equipped with various handy packing accessories. This makes it the ideal entry-level packing bench.

personalised packing benches

All Treston packing benches are modular and can be equipped with numerous accessories. This way, the packing benches can be configured to optimally support specific tasks. By adding smart accessories and, where necessary, incorporating technology and customization, the perfect packing bench can be assembled.

Curious about the possibilities?

Book an appointment with one of our workspace specialists.



mobile workspaces

Our mobile workspaces are available in a standard version but can also be customized. They can be equipped with various accessories such as a built-in battery. The benefits of our mobile workspaces with battery include:



- Working independently of mains power thanks to maintenance-free batteries
- Integrated charger for charging via any power outlet
- AGM or lithium-ion battery solution
- High-capacity inverters for laser printers
- Height-adjustable work surfaces and storage compartments
- Robust
- Branding options available if desired



logistics



add-ons for the packing bench

By integrating smart accessories, ergonomic tools, technology, and custom solutions into the packing bench, we can provide our clients with the most suitable workspace solutions. These solutions are perfectly tailored to the wishes and needs of the users and are designed to achieve set goals while continuously supporting changes in the workplace and processes.

smart accessories

We offer an extensive range of accessories, including retractable printer slides, holders for tablets and scanners, height-adjustable monitor mounts, control lighting, and smart storage solutions for integration on the packing bench. Many of these accessories are interchangeable and can be used not only on packing benches but also on carts, trolleys, and mobile workstations.



retractable printer slides



professional overhead lighting



height adjustable monitor mounts



secure energy rails



convenient taperroll holders

integration of technology

To support operations, we offer a range of automation solutions for integration on the workspace. These solutions enhance the speed and efficiency of tasks. Examples include an Andon signaling system, built-in scales, specific scanning equipment, or pick-to-light systems.

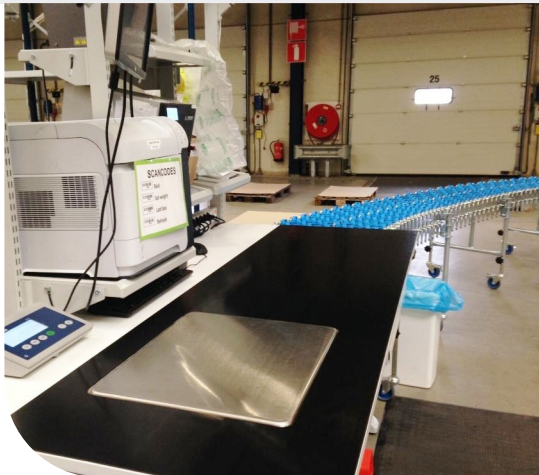

customized packing benches

An example of integrating custom solutions into an off-the-shelf packing bench could be the installation of a scale or the use of anti-friction plastic for smooth and natural movement when performing various tasks at the workspace.

ergonomic standing mats

We supply heavy-duty, durable anti-fatigue mats with beveled edges to prevent tripping. The mats are available in a stand-alone version, but with our convenient puzzle system—where the mats feature cut-out puzzle edges—we can provide solutions in any desired size and shape.

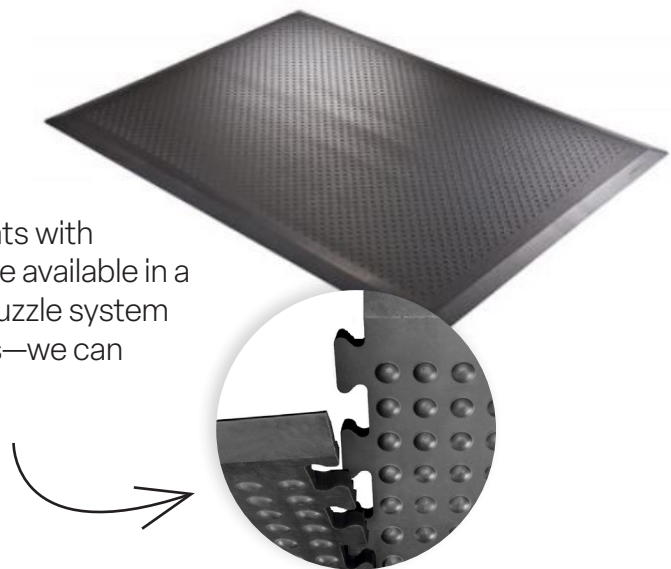

did you know...

...our mats are equipped with the AGR certification, which means they help reduce back pain. The mat's surface provides cushioning, promotes better circulation in the legs, and supports a correct working posture.

logistics



trolleys & carts

Our extensive range of trolleys and carts for logistics is designed to enhance the speed and efficiency of various logistical tasks while also contributing to good ergonomics in the warehouse.

carton storage trolleys

Our off-the-shelf and customized carton storage trolleys provide extra space for storing flat cardboard sheets in various sizes close to the workspace. This helps prevent wasting time. The trolleys are lightweight and easy to move.

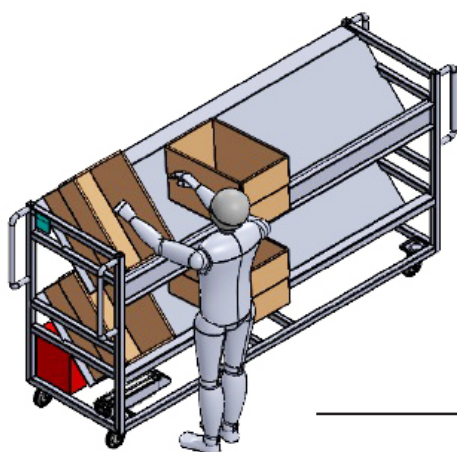
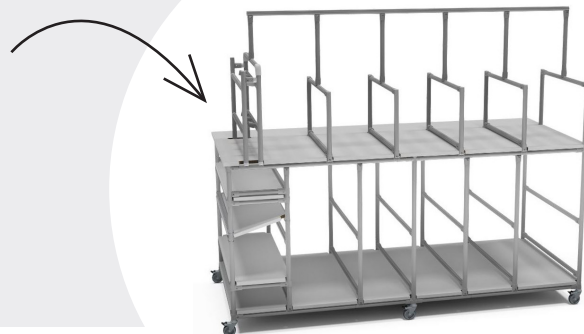

order picking carts

Our order picking carts can be electrically powered and customized to carry loads of up to 750 kg. Their ease of mobility contributes to higher productivity and better ergonomics, making them an ideal solution for use in a logistics work environment.

HUMAN
WORKSPACE
the workspace specialist

view our
complete
range





**HUMAN
WORKSPACE**

100% custom solutions

To fully tailor our workspace solutions to the wishes and needs of our clients, we offer the possibility of 100% custom solutions. For this we use profile and tube systems and other materials. From our own engineering department and production facility, we create and produce any desired custom workspace solution, from prototype to production of both small and large batches.

logistics companies that use our
workspace solutions



de Bijenkorf 

 wehkamp



MICHAEL KORS

ceva
LOGISTICS

 DP WORLD

AVNET®

PANDUIT™



Timberland bol.

TVH 

stichd®

WORLDPACK

THE
NORTH
FACE 

GXO

Alliance
Healthcare 

online 3D configurator

Go to [humanworkspace.nl](https://www.humanworkspace.nl) and customize your workbench in 4 steps:

1. Choose the desired **frame** and **worktop**.
2. Select the **accessory frame**, available in various sizes and compositions.
3. Choose the **accessories** that support the specific tasks.
4. Select from various **options** such as wheels, drawer cabinets, and trolleys.

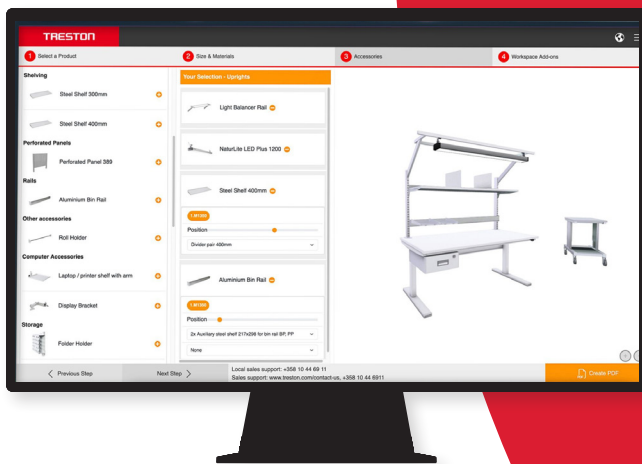

visit our
showroom

monday to friday
09:00-17:00

Scan the QR-code
to book an
appointment



Human Workspace BV

Mechelaarstraat 17
4903 RE Oosterhout (n-br)

T: +31(0)162 454 383

E: sales@humanworkspace.nl

W: www.humanworkspace.nl



HUMAN
WORKSPACE